

OPERATING INSTRUCTIONS
MODEL: 990 CH

ESSE



INTRODUCTION

Your Esse 990 is a combination appliance providing a hot plate, 2 ovens of different temperature, room heat and a high output boiler.

The hinged hob covers are referred to as bolster lids and finished in stainless steel. They are designed to reduce heat losses and therefore fuel use from the appliance when not cooking, and build up or conserve higher hotplate temperatures for when cooking is required.

A damper is fitted to the flue connector.

Fig.1

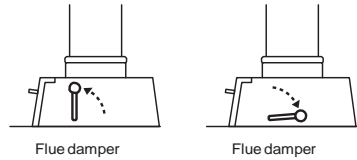

CONTENTS

Safety Notes	Page 2	Ash Removal	Page 5
Before Using Your Cooker	Page 3	Types of Fuel	Page 6
Controls	Page 3	The Wood Burning Process	Page 6
Lighting and Controlling the Cooker	Page 4	Operating Tips	Page 7
Cooking On The Hotplate	Page 4	What Type of Wood is Best	Page 7
General Advice	Page 4	The Importance of a Healthy Flue	Page 8
Important Notice	Page 4	Cleaning the Flue Ways	Page 9-11
Cooking in the Ovens	Page 5	Cleaning the Exit Flue	Page 11

SAFETY NOTES

Please refer to Installation Instructions manual to ensure appliance has been correctly installed and is connected to a suitable flue. Failure to do so will seriously inhibit the cooker's performance and could be potentially fatal.

Properly installed, operated and maintained, this appliance will not emit fumes into the dwelling. However occasional fumes from deashing and re-fuelling may occur. Persistent fume emission is potentially dangerous and must not be tolerated. If fume emission persists, open doors and windows to ventilate the room. Let the fire burn out or eject and safely dispose of fuel from the appliance. Once the fire is cold, check the flue and chimney for blockages and clean if required. Do not attempt to relight the fire until the cause of the fume emission has been identified and corrected. Seek expert advice if necessary.

An adequate air supply for combustion and ventilation is essential. Air openings provided for this purpose must not be restricted. Also if simultaneous operation of other heating appliances is required within the kitchen ensure that there is sufficient ventilation. Should it be likely that children, aged or infirm people approach the appliance whilst the fire door is open then a fireguard manufactured in accordance with BS 6539 should be used. Also warn children not to sit or stand on the appliance or use it as a stool or step to access cupboards or shelves above the appliance.

Avoid the use of aerosol sprays in the vicinity of the cooker when it is in operation and do not heat any unopened airtight con-tainers.

Ensure that precautions are taken when deep fat frying, never leave the appliance unattended and ensure you have fire safety equipment available such as a fire blanket in case of emergency.

When operating the ESSE 990 CH use the tools provided and follow these instructions carefully.

BEFORE USING YOUR COOKER

Ensure that any plastic film used to protect surfaces has been removed from the bolster lids and from the inside of oven doors. The hotplate has been coated with oil at the factory to prevent rusting and therefore will require wiping with a damp cloth and drying with a tea towel or kitchen roll.

CONTROLS

OVEN/BOILER DAMPER

When in the 'oven' position (fully clockwise) the heat is directed to the hotplates and ovens, enabling fast heat up of these areas and reduced hot water.

When in the 'boiler' position (fully anti-clockwise) the heat is directed through the boiler heat exchanger for maximum hot water output.

Consequently, oven and hotplate temperatures will be slower to heat up when in boiler mode.

BOILER THERMOSTAT

The thermostat controls the burning rate of the fire and hence the boiler output. The minimum setting is 60°C when turned fully anticlockwise, and the maximum water temperature is 90°C when fully clockwise. Water temperature between the minimum and maximum can be chosen by turning the dial accordingly. When the thermostat senses that the boiler is at the correct temperature, it will close the air intake and reduce the burning rate of the fire.



IMPORTANT NOTE

The boiler thermostat is the primary device for controlling the burning rate of the cooker and must be turned to maximum to achieve high oven temperatures, with the oven/boiler damper control in the 'oven' position.

FLUE DAMPER (fig. 1)

Open the damper (push away from you) when lighting or refuelling the fire. Only close the damper once the fire is warm.

SHAKING GRATE

To de-ash the grate, open the ash door and using the tool supplied, push and pull the riddling grate vigorously several times, causing loose ash to fall into the ash pan.

FLUE BOX DOOR SCREW CONTROL

Fully or partially opening the flue box door by winding the screw in will reduce the flue pull on the fire and thus extend burning times. Its effect is dependant upon prevailing flue conditions which may vary according to wind and weather. If there is any sign of smoke leakage from this control, ensure it is closed.

LIGHTING AND CONTROLLING THE COOKER

Open flue damper by moving the lever away from you.

Open the fire door and using either rolled up paper or a firelighter on top of which small sticks of dry kindling wood has been placed, light the fire. Depending on how well the chimney is pulling, close or partially close the door until the kindling is well alight.

Reload the fire with small logs or smokeless solid fuel. You may experience smoke back out of the firebox when reloading as the chimney may still be in the process of warming up.

Allow the fuel to start to burn and when appropriate continue to refuel, building up the size of firebed.

When refuelling is required, open the door slowly to minimise the risk of smoke and flames escaping.

Once the fire is well established, close the flue damper by moving the lever towards you.

Your cooker should not be used as an incinerator and only recommended fuels are to be used.

COOKING ON THE HOTPLATE

The hotplate is a heavy iron casting, machined flat on the cooking surface. Heat up from cold or low temperature can be achieved quite quickly with a fast burning fire. Leave the bolster lids down to allow the hotplate to warm up. Once hot, the hotplate will retain temperature for long periods even as the fire burns down.

Machined base pans are essential, as heat transfers by conduction. Wipe the hotplate regularly to remove anything that might interfere with the contact between the hotplate and the base of the pan.

The hotplate is hottest to the left, over the fire, the temperature decreasing towards the right.

Always keep the bolster lids down when not using the hotplate.

Food may be cooked directly on the hotplate, for example griddle scones, burgers, steaks and Welsh Rarebit. Eggs can be cooked on the hotplate with the lid closed to cook evenly, similarly bread may be toasted under the bolster lid. Bake-o-lite paper is useful to ensure the hotplate remains clean in such instances.

GENERAL ADVICE

Always use a heat proof glove when opening and closing doors, as handles and surfaces will be hot.

Take care when hanging towels etc from the rail, particularly in front of the firebox. The doors should generally remain closed for safety.

IMPORTANT NOTICE

It is important to understand how a wood or solid fuel heating system works and its limitations. Before specifying your cooker you will have assessed your heating requirements and calculated the heating load for your system, or how much heat is required to heat the hot water and radiators to which you are connecting the cooker. The plumbing must ensure a minimum return water temperature of 56 c, otherwise the boiler face will become covered in tar. If the water in the boiler is not above this temperature, the boiler over cools the fire which prevents effective combustion. This is inefficient as not all the available heat is released from the fuel and furthermore the tar (the unburned fuel) clogs the flue ways in the cooker and insulates the boiler, resulting in less effective heat transfer. Ideally, a Boiler Control Unit will have been installed, which is the most effective solution to maintaining a correct return water temperature.

Choice of fuel

Should you burn smokeless fuel or wood? If you are located in a smoke control zone, then you have to burn an approved smokeless fuel. The boiler output will be higher with solid fuel than wood. Solid fuel is a more concentrated energy source, therefore it is possible to load the firebox with more potential energy in the form of solid fuel than wood. It will also burn a longer period without refuelling for the same reason.

When burning solid fuel it is important to de-ash the grate prior to refuelling, to ensure maximum airflow through the bed of coals, whereas with wood it is preferable to leave the firebox undisturbed and allow ash to build up on the grate. To minimise the chance of the cooker smoking back when you refuel, before opening the fire door open the flue damper and set the oven/boiler control to the oven mode. Allow a minute or two for the airflow within the appliance to stabilise, then slowly open the fire door and refuel. If you encounter frequent smoking back, have the chimney draught checked to ensure it is a minimum of 0.6"wg. check the flueways in the cooker have not become blocked with soot or tar, similarly the flue and chimney.

COOKING IN THE OVENS

The cooker has 2 ovens. Please refer to the table for comparable temperature guides in degrees Centigrade.

	Main oven	Lower oven	Hotplate (hottest)	Hotplate (coolest)
80 mins from lighting	190	120	400	140
Normal running	200	140	320	220

Temperatures given are approximate and based on refuelling solid fuel at approximately 1.4kg hour, with cooker set to 'oven' mode, flue draught 0.07" w.g.

Opening the flue damper will allow heat to pass directly to the chimney via the left side of the hotplate, useful for boosting the hotplate temperature without increasing the main oven temperature if required.

The temperature dial on the main oven door provides an indication of the oven temperature (See Fig.2) and by comparison the temperature of the adjacent oven. Since the dial is in the door, the thermometer will register a lower temperature when the door is opened although the oven itself will not lose temperature so quickly. The dial can take a short time to register the correct temperature once the door is again closed.

The ovens are all of equal depth and each is equipped with wire shelves which can be set to the desired height. The shelves have anti-pull out stops on their ends to prevent them from being pulled out inadvertently; to remove a shelf, pull forward until the stop is reached, then lift at the front and pull out of the oven. Use reverse procedure to refit. If the shelves pull straight out then they are in back to front!

ASH REMOVAL

When burning wood, only remove small amounts of ash from the grate, leaving ideally 30mm depth of ash in the bottom for best performance.

When burning solid fuel, de-ash regularly.

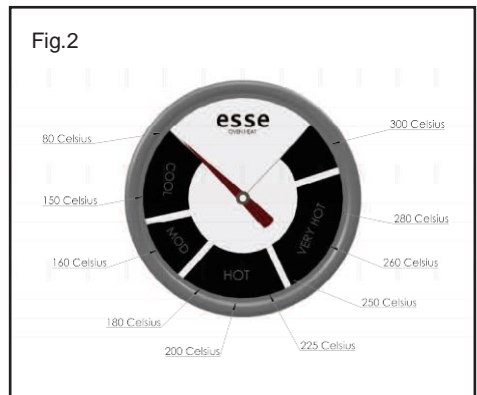

TYPES OF FUEL

SEASONING AND STORING FIREWOOD

Wood, which has recently been cut and is still full of sap and water is known as "green" wood.

Greenwood will generally burn poorly and inefficiently, because it can have over 50% water in its cells. It may be hard to light, smoulder, not put out any heat and cause more than the usual amount of creosote to build up in your chimney.

So your aim should be to dry the wood out to below 25% moisture content, this process is called seasoning. As the name implies, you should store your wood for a season or so, while it dries, but there are things you can do to speed up seasoning by cutting the wood now rather than just before you use it.

Wood is composed of bundles of microscopic tubes that were used to transport water from the roots of the tree to the leaves. These tubes will stay full of water for years even after a tree is dead. This is why it is so important to have your firewood cut to length for 6 months or more before you burn it, it gives this water a chance to evaporate since the tube ends are finally open and the water only has to migrate a foot or two to escape. Splitting the wood helps too by exposing more surface area to the sun and wind, but cutting the wood to shorter lengths is of primary importance.

Here's how you can tell whether your wood is ready or not: Well seasoned firewood generally has darkened ends with cracks or splits visible, it is relatively lightweight, and makes a clear "clunk" when two pieces are beat together. Green wood on the other hand is very heavy, the ends look fresher, and it tends to make a dull "thud" when struck.

Another thing you can do to help is store your wood properly. Store it off the ground by building the pile on some longer logs (or whatever method you can devise). A shed or shelter with an open side makes an ideal storage place, as the air can circulate around the logs and help to dry them out. Unventilated spaces or plastic tarps, which never get taken off will prevent the drying and evaporation process and cause moulds and rot. So, if a tarp is your only option, take it off frequently to air the wood on fine days. And remember to put it back on again. Seasoned firewood will reabsorb large amounts of water if exposed to rain, snow and excessive dew, which is liable to make it rot and be unfit for making a good fire.

When you build up a store of firewood, remember that the wood may start to deteriorate after 4 to 5 years, although this is of course variable and depending on storage conditions and species involved.

THE WOOD BURNING PROCESS

Understanding what happens when wood is burnt will enable you to burn wood in a more environmentally friendly way, reduce the maintenance required for your chimney and get more out of your wood. There are 3 stages in the wood-burning process:

Evaporation

When you light the cooker a lot of energy will be needed at first to boil away any moisture, which is left in the wood. Using energy to drive off excess water in firewood robs the cooker of energy needed for an efficient and clean burn. Also, much of the energy wasted in evaporating water is energy that could have heated the hot-plate and ovens. This is a waste of wood, money and effort. The presence of all that moisture tends to keep "putting out" the fire, and therefore making it burn very poorly, which tends to produce a lot of creosote and pollution.

Emissions

As the heat of the fire intensifies, waste-gases (smoke) are released from the wood.

Unburned smoke is emitted into the air either as pollution, or condensed in the chimney causing creosote build-up. It takes time for the air in your chimney to heat up. When it is still cold you get an effect similar to the condensation of hot breath on a colder window or mirror. So when the by-products of combustion (smoke in the form of gases) exit the cooker, and flow up into the relatively cooler chimney, condensation occurs.

The resulting residue that sticks to the inner walls of the chimney is called creosote. Creosote is formed by unburned, flammable particulates present in the smoke. It is black or brown in appearance. It can be crusty and flaky, tar-like, drippy and sticky or shiny and hardened. Quite often, all forms will occur in one chimney system.

If the wood you are using is water logged, or green, the fire will tend to smoulder and not warm the chimney sufficiently. Wet wood causes the whole system to be cool, and inefficient. In contrast: dry wood means a hot fire, which results in a hot flue, and a hot flue means much less creosote clogging up your chimney.

Charcoal

When most of the tar and gasses have burned the remaining substance is charcoal (ash in it's finer form). A hot bed of charcoals and ash can enhance the combustion process when burning larger pieces of wood. Start with a small fire to develop a bed of glowing embers. As the charcoal bed develops and the cooker heats up, slowly add larger and larger pieces of wood. It takes time to build a good charcoal bed, but it is well worth the effort. Only empty excess ash periodically and always leave a bed of ash on which to light the next fire.

OPERATING TIPS

By taking time to get to know your cooker, following our maintenance guidelines and using good quality fire-wood you should enjoy trouble free operation of your Woodfired cooker but it is also worth bearing in mind these useful operating tips:

- Don't leave the cooker lit for long periods in slumbered down mode (as you would for overnight burning), open the air control and bank up the fire periodically to heat up the cooker and flue to prevent soot build up.

WHAT TYPE OF WOOD IS BEST

The difference between 'hard' and 'soft' woods is the density of their cells or fibres.

As a general rule, the deciduous trees (those that lose their leaves in the autumn) are usually thought of as hardwoods and the evergreen trees (such as pines, firs and larches) as the softwoods. But generalisations are of course always subject to many exceptions. Some evergreens may well be harder than some deciduous trees. Birch, for example, is not very hard at all. So we should understand that there is a whole range of densi-ties amongst our tree species, including medium dense woods, which cannot be satisfactorily classed as hard or soft.

Firewood tends to be sold by volume rather than weight. Assuming that the wood is reasonably dry, the weight of a square foot of good hardwood may be double of that of a square foot of softwood. This means that the same volume of hardwood will provide you with more fuel to burn than an equal amount of softwood, simply because it contains more substance.

(N.B. The price of hardwood will normally not be double that of softwood, because it took the same amount of labour to prepare. So, if a trailer full of hardwood costs more than the same size trailer full of softwood, the more expensive option may well be the most economical.)

The other advantage of good hard firewoods are that the cooker does not need to be fed as often and the charcoal-beds made by the glowing wood may burn more easily overnight.

However, the ideal situation would be to have a store of both hard and soft woods, because the softer woods also have distinct advantages. They light more easily than the slower burning hardwoods and if the softwoods are dry, they create a hotter, more intense fire. The draught created by the hotter fire moves the air up the chimney faster.

After reading the notes opposite about the burning process, you will understand that means less pollution in the form of smoke and less creosote condensation in your chimney.

The denser hardwoods tend to smoulder more easily when the fire is lit first, so their flue gas temperature will be much cooler.

Because softwoods like pine and larch contain a lot of resins and pitch, a popular misconception is that they will fur up the chimney with creosote more easily than a hardwood like oak. This is not necessarily true at all. It is not the pitch that is the problem, it's the water IN the pitch. Once the water in the wood has evapo-rated, that pitch becomes high octane fuel! When dry, softwoods burn extremely hot!

There is also the matter of seasoning to be considered. When you buy wood, it will usually have been cut in the winter of the year you buy it. Hard woods tend to take longer than softwoods to fully dry out.

Softwoods cut in the previous winter should, with proper storage, be ready to burn the next autumn, where-as many hardwoods may take a bit longer than that. Oak, for example, is very slow to dry out and ideally left for two years. It is also possible to purchase pre seasoned wood.

Summarising we can say that it is always sensible to buy this year for next years fuel supply and that it is very handy to have both soft and hardwoods. You can use the softwoods to start a good fire and you will have additional control over the fire (in addition to the cookers controls) by adding slower burning wood to fast ones if you want to leave the cooker without tending it for a while. Alternatively you can add some fast burning softwood logs to the slower hardwood logs to instantly revive a fire, which has been neglected.

THE IMPORTANCE OF A HEALTHY FLUE

The successful operation of your range cooker is entirely dependent on the adequate performance (pull) of the chimney or flue to which it is connected. The following maintenance guidelines will be pointless unless the flue is also maintained and cleaned regularly. How often it needs cleaning will depend on the quality and moisture content of the wood you burn but an annual clean is recommended. A partially blocked or dirty flue can have disastrous implications for an otherwise perfectly installed cooker as can be seen below. Cooker A has been used regularly for over a year following these maintenance guidelines and with a clean flue drawing correctly. Cooker B was just 6 weeks old when the picture was taken and shows how quickly tar deposits will build up if the flue performance is poor and clogged with old soot as it was in this case.

(N.B. Cooker shown for illustration is not a 990 CH)

Fig.3

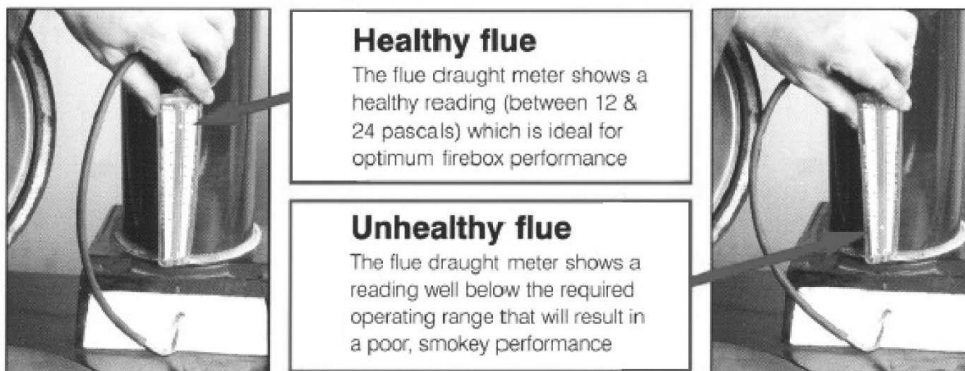

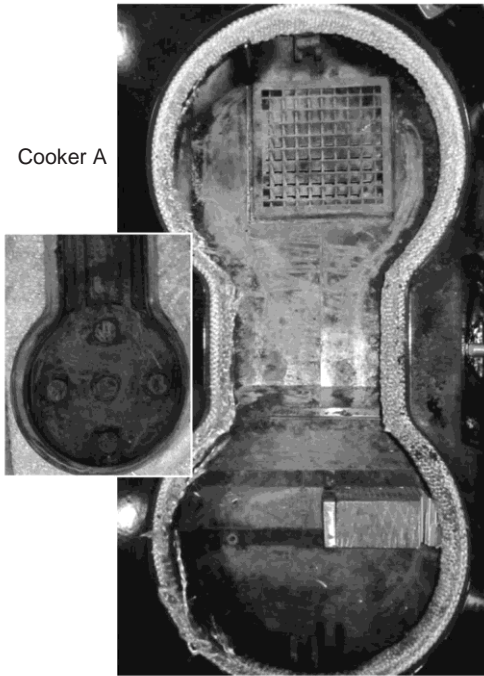

Cooker A

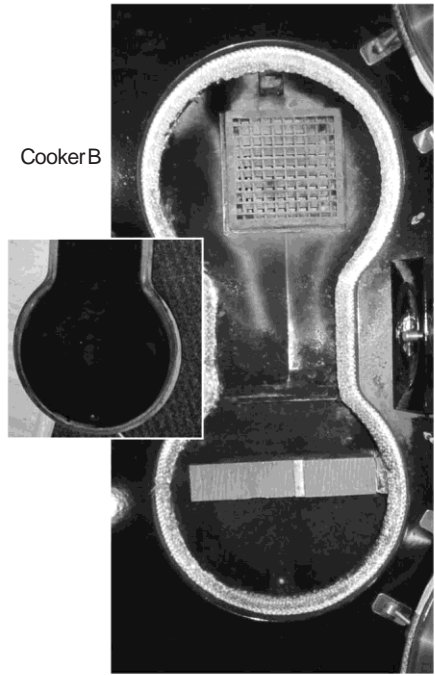

Cooker B

Good draft & clean flue = efficient wood burning, clear flue ways, minimal soot and no tar deposits.

Poor draft & dirty flue = inefficient wood burning, blocked flue ways, lots of soot and tar deposits.

CLEANING THE FLUE WAYS - Every 3 months

Always carry out cleaning procedures when the cooker is out and has been allowed to cool sufficiently to avoid burns. With time and experience you will be able to gauge the intervals between flue way cleaning more accurately. It will vary depending on the quality of your firewood and performance of your flue. Take time to get to know your cooker and inspect it at regular intervals for the first 6 months. We recommend that a flue brush of the type shown below (Fig 5) is used to clean the flue ways. Its flexible wire handle is ideal for pushing the brush head round bends and into narrow spaces.

HOTPLATE AND PRIMARY FLUE WAY

Remove the hotplate securing screws and use the hotplate lifting tools (Fig 4) that came with your cooker to remove the hotplate and if required give the surfaces under the hotplate and above the firebox and top oven a light scrub with a wire brush and vacuum out any debris.

Fig.4



Fig.5

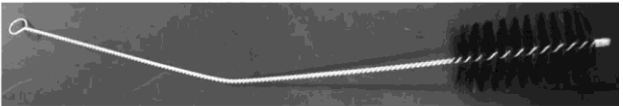

Fig.6

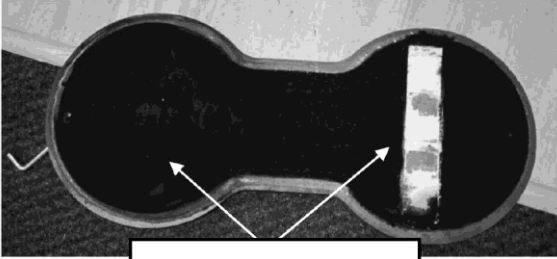
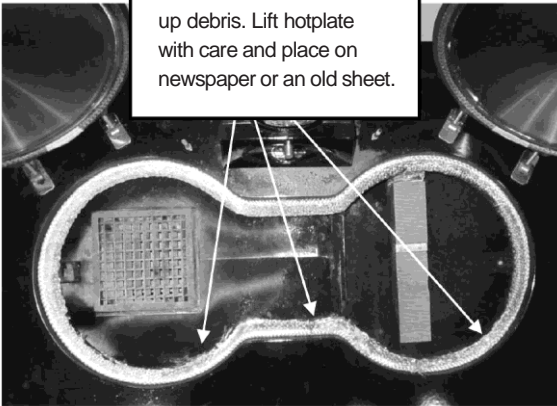

Fig.7



Lightly brush surfaces with a wire brush and vacuum up debris. Lift hotplate with care and place on newspaper or an old sheet.

Fig.8



FLUE BOX AND REAR FLUE WAY

Remove the front of the flue connector box and insert the flue brush from left to right, angling the brush down at 45°. Once you find the flue way entrance push the brush down until it stops then gently but firmly pull back and forth 3 or 4 times then remove the brush. Dislodged soot will fall into the tray between the ovens.

Fig.9

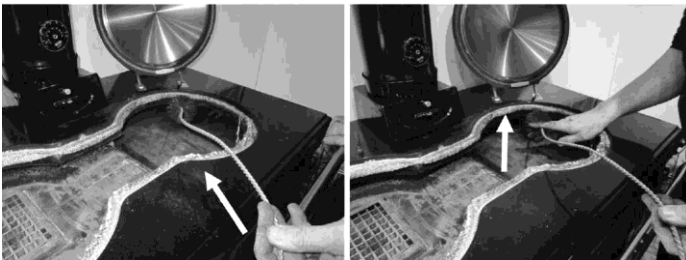

RIGHT SIDE FLUE WAY

Next insert the brush at a shallow angle as shown above. The brush will need to turn 90° into the flue way so steady pressure will be needed to help the brush head round the bend. Once in, work the brush up and down and front to back as the flue way runs along the entire depth of the ovens. Again, soot will fall into the trap between the ovens.

CLEANING THE FLUE WAY BETWEEN THE OVENS

Remove the inspection cover in the base of the main oven and insert the flue rake, raking from side to side and making sure the rake reaches the back and the side of the flueboxes. Vacuum the soot.

Fig.10



Fig.11



With the scrapping tool pull any soot or tar granules into the open space.

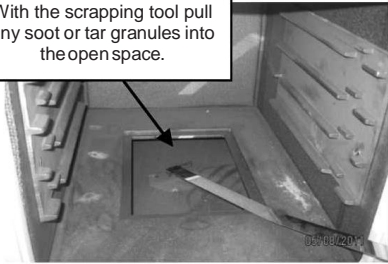

Fig.12

CLEANING THE EXIT FLUE - Every 12 months

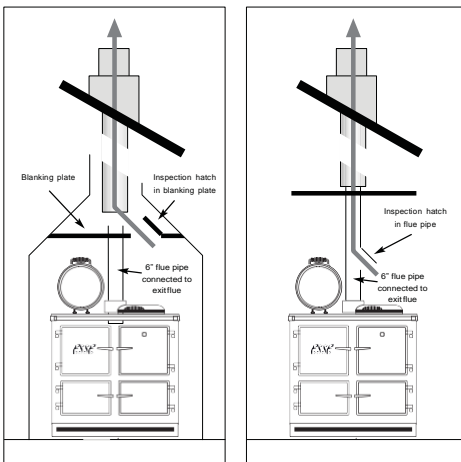

Fig.13

It is essential to maintain the integrity and cleanliness of the flue to ensure that your cooker continues to perform at its best. When your cooker was installed the main flue should have been equipped with an inspection hatch; either in the blanking plate above the cooker next to the flue pipe (Fig 13) or in the flue pipe itself.

These hatches are designed to allow periodic access to the flue for cleaning which should ideally be done by a chimney sweep. Chimneys and flues vary widely in terms of size, shape, length and construction, but the principles of the way they work are the same. Keeping them clean and clear is essential to maintain the optimum performance of any woodburning or multi-fuel appliance.

CONDITIONS OF GUARANTEE

Your ESSE cooker is guaranteed against defects arising from faulty manufacture for three years, subject to the following express conditions:

- This cooker must be commissioned by your ESSE Dealer (or an authorised HETAS engineer) upon installation. The details must be recorded on the Commissioning card and registered with ESSE by returning the completed card. The guarantee period commences upon delivery of the cooker (subject to receipt of the correctly completed warranty card).
- The cooker has been used for normal domestic purposes only, and in accordance with the manufacturer's instructions.
- The cooker is serviced annually by the ESSE Dealer or authorised HETAS engineer, and the Service record completed. The cooker must not be serviced, maintained, repaired taken apart or tampered with by any person not authorised by us.
- Any cooker or detective part replaced shall become the Company's property.

EXCLUSIONS

This guarantee does not cover:

- Parts deemed to be replaceable in the normal usage of the cooker. These parts are listed herewith: hotplate seal, bolster ropes, bottom grate, oven accessories, door seals and ash pan.
- Enamel damage; the vitreous coating on your cooker is in effect an extremely thin layer of glass and as such displays all the characteristics of glass. It can easily be damaged by impact, or by spillage of cold liquids onto a hot surface. Such damage cannot be covered under this guarantee. (See also intermittent use of your cooker, below).

This guarantee is personal to the original purchaser and is non-transferable.

INTERMITTENT USE OF YOUR COOKER

In the event of intermittent use and prolonged shutdown, it should be noted that in some circumstances enamel may be displaced due to ingress of damp. Whilst this is rare, it is most likely to occur in situations where the unused cooker remains in a unheated property. There is a layer (known as the groundcoat) between the vitreous enamel surface and the cast iron. Groundcoat is porous and if exposed (e.g. after a chip in the vitreous enamel coat), may allow damp to penetrate behind the vitreous enamel and spread through the groundcoat. Surface oxidation of the cast iron may thereafter occur, causing the vitreous enamel to fall off. Such damage will not be covered by your warranty. We recommend that a light coating of petroleum jelly be applied to any damaged areas when the cooker is not in use to help keep out the damp, in addition to following instructions in your Operating manual.

CUSTOMER CARE

In the event you should require spare parts, please order through your ESSE dealer. Should you have cause for dissatisfaction with your cooker, you should contact your ESSE dealer, who will, in most instances, be able to offer you immediate assistance. You will be required to give the following details.

- Your name, address and postcode.
- Your telephone/contact details.
- Clear and concise details of the fault.
- Model and serial number of the cooker.
- Purchase date (please note that a valid purchase receipt or guarantee documentation is required for in-guarantee service calls).

